

Dach- & Fassadenverkleidung

mk



Verkleidungsprofile	Seite 1 - 6
Hartschaumwinkel	Seite 7 - 8
Fassadenprofile	Seite 9 - 14

Verkleidungsprofile Weiß

Die WETTERPAN - Verkleidungsprofile bieten eine permanent gepflegte Fassade und Dachverkleidung. Hergestellt aus hochwertigem Fensterkunststoff sind sie perfekt für die widrigen Umstände im Außenbereich geeignet. Die Bearbeitung ist mit konventionellen Werkzeugen möglich und eine Vielzahl von Zubehörprofilen gewährleisten eine schnelle und mühelose Montage.

Verkleidungsprofil mit V-Fuge

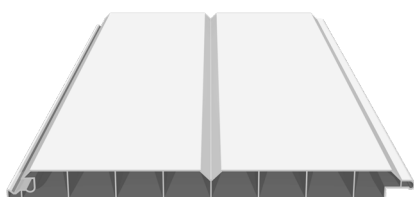

Maße + Länge	Deckbreite	VE	Art.-Nr.
17 x 6000 mm	200 mm	30 m / 6 m ²	020
17 x 3000 mm	200 mm	15 m / 3 m ²	020/3

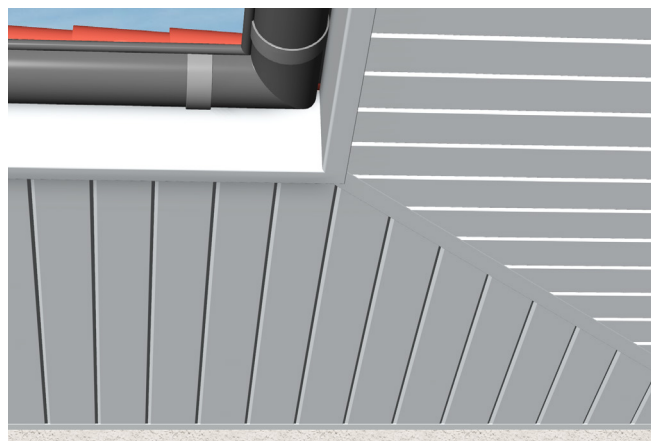

Verkleidungsprofil ohne Fuge

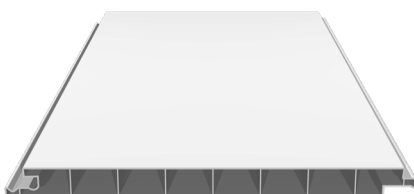

Maße + Länge	Deckbreite	VE	Art.-Nr.
17 x 6000 mm	200 mm	30 m / 6 m ²	017

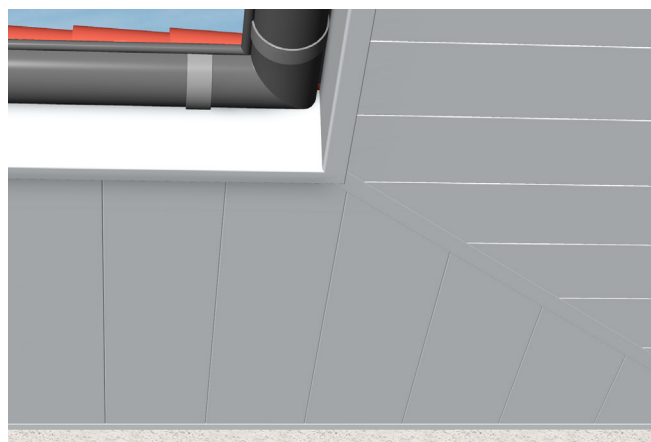

Verkleidungsprofil mit U-Fuge

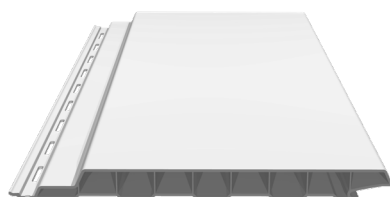

Maße + Länge	Deckbreite	VE	Art.-Nr.
17 x 6000 mm	180 mm	30 m / 5,4 m ²	019

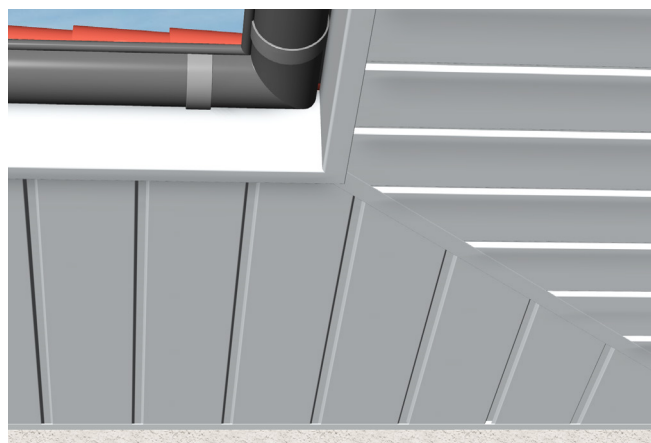

Verkleidungsprofile Weiß

- Zubehörprofile -

U-Profil

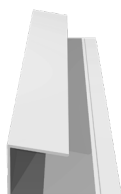

Maße + Länge	VE	Art.-Nr.
24 x 21 x 6000 mm	60 m	021

H-Profil

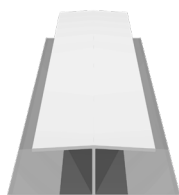

Maße + Länge	VE	Art.-Nr.
47 x 6000 mm	60 m	023

Eck-Profil

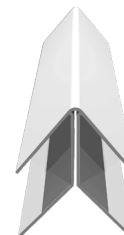

Maße + Länge	VE	Art.-Nr.
37 x 37 x 6000 mm	60 m	022

U-Profil (zweiteilig)



Maße + Länge	VE	Art.-Nr.
41 x 20 x 6000 mm	60 m	024

Eck-Profil (zweiteilig)



Maße + Länge	VE	Art.-Nr.
60 x 60 x 6000 mm	30 m	025

Befestigungsschraube

für Art.-Nr. 020 & 017



Empfohlene Schraube:

Senkkopf Edelstahlschraube 3 x 25 mm
(bauseits, nicht im Lieferprogramm enthalten!)

Befestigungsschraube

für Art.-Nr. 019



Empfohlene Schraube:

Panhead Edelstahlschraube 3,5 x 30 mm
(bauseits, nicht im Lieferprogramm enthalten!)

Hartschaumwinkel



Maße + Länge	VE
110 - 310 x 40 x 6000 mm	12 m
423 x 40 x 6000 mm	12 m

Die Hartschaumwinkel aus PVC-Hartschaum eignen sich besonders als Abdeckung für Sparren und Dachränder, sowie der Verkleidung von Fenster- und Türleibungen.

Weitere Informationen finden Sie auf Seite 7.

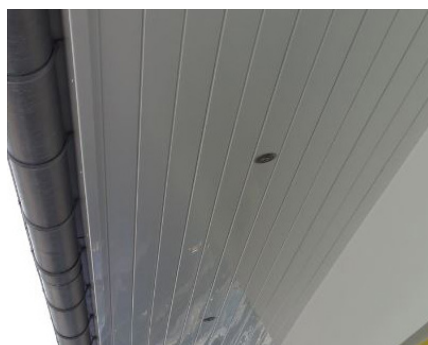
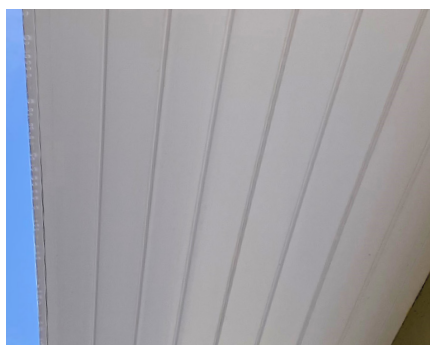

Verkleidungsprofile V-Fuge - mit Dekor-Folie

Verkleidungsprofil V-Fuge

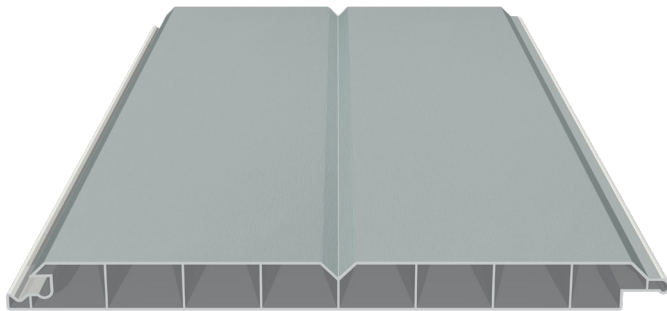

Maße + Länge	Deckbreite	VE	Art.-Nr.
17 x 6000 mm	200 mm	30 m / 6 m ²	020 K

Montage:

- Befestigung auf einer Holzunterkonstruktion
- max. 50 cm Lattenabstand
- Montage mit Befestigungsklammer
- genügend Dehnaabstand beachten
- ausreichend Hinterlüftung sicherstellen

Lager - Sortiment

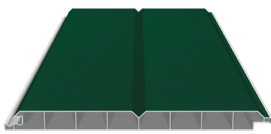

Moosgrün
Art.-Nr. 020 K 0505

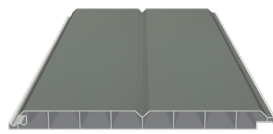

Basaltgrau
Art.-Nr. 020 K 1205

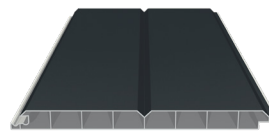

Anthrazitgrau
Art.-Nr. 020 K 1605

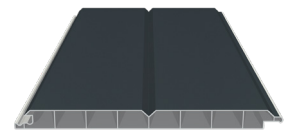

Anthrazitgrau Glatt
Art.-Nr. 020 K 1605-083

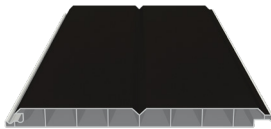

Schwarzbraun
Art.-Nr. 020 K 1805



Eiche Dunkel
Art.-Nr. 020 K 2089

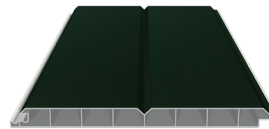

Dunkelgrün
Art.-Nr. 020 K 2505

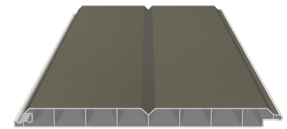

Quarzgrau
Art.-Nr. 020 K 3905



Lichtgrau
Art.-Nr. 020 K 5105

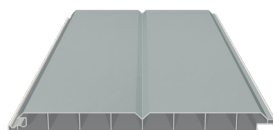

Silbergrau
Art.-Nr. 020 K 5505

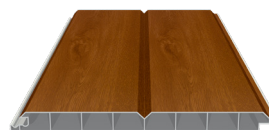

Golden Oak
Art.-Nr. 020 K 8001



Nussbaum
Art.-Nr. 020 K 8007

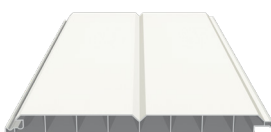

Weiß
Art.-Nr. 020 K PX 5205



Cremeweiß
Art.-Nr. 020 K PX 7905



Black Ulti Matt
Art.-Nr. 020 K PX 47097

**weitere Dekore
auf Anfrage**

Verkleidungsprofile V-Fuge - mit Dekor-Folie

- Zubehörprofile -

U-Profil

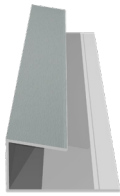

Maße + Länge	VE	Art.-Nr.
24 x 21 x 6000 mm	60 m	021 K

H-Profil

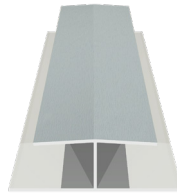

Maße + Länge	VE	Art.-Nr.
47 x 6000 mm	60 m	023 K

Eck-Profil

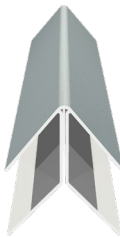

Maße + Länge	VE	Art.-Nr.
37 x 37 x 6000 mm	60 m	022 K

Befestigungsklammer



VE	Art.-Nr.
100 Stück	026

- ✓ außen und innen verwendbar
- ✓ witterungsbeständig
- ✓ wartungsfrei / nie wieder streichen
- ✓ 100 % recyclebar
- ✓ Verarbeitung wie Holz
- ✓ 10 Jahre Garantie auf UV- und Witterungsbeständigkeit
- ✓ sehr reinigungsfreundlich
- ✓ Made in Germany
- ✓ leichte Montage - vertikal und horizontal einsetzbar
- ✓ moderne attraktive Farben

Hartschaumwinkel



Maße + Länge	VE	Art.-Nr.
310 x 40 x 6000 mm	12 m	S31040 K

Hartschaumwinkel



Maße + Länge	VE	Art.-Nr.
235 x 40 x 6000 mm	12 m	S23540 K

Hartschaumwinkel



Maße + Länge	VE	Art.-Nr.
185 x 40 x 6000 mm	12 m	S18540 K



Dekor: Anthrazitgrau



Dekor: Golden Oak

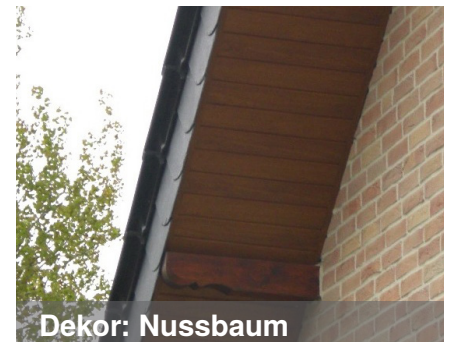

Dekor: Nussbaum

Verkleidungsprofile ohne Fuge - mit Dekor-Folie

Verkleidungsprofil ohne Fuge

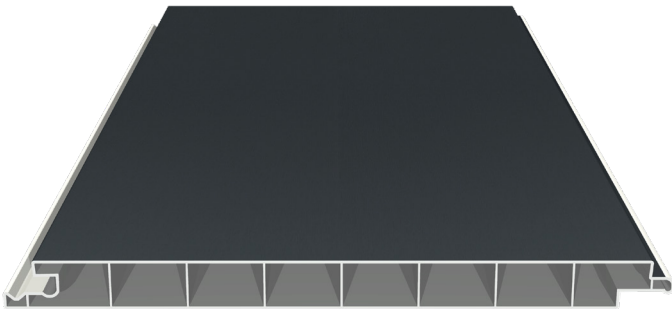

Maße + Länge	Deckbreite	VE	Art.-Nr.
17 x 6000 mm	200 mm	30 m / 6 m ²	017 K

Anwendungsbereiche:

- Verkleidung von Dachüberständen wie z.B. der Traufe
- Verkleidung von Giebeln oder Dachgauben
- Verkleidung von Balkonen-Unteransichten
- Verkleidung von Wänden an Garagen, Carports, Chalets oder Gartenhäusern

Lager - Sortiment



Moosgrün
Art.-Nr. 017 K 0505

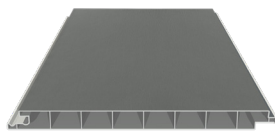

Basaltgrau
Art.-Nr. 017 K 1205

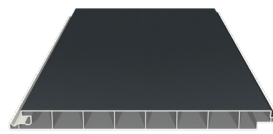

Anthrazitgrau
Art.-Nr. 017 K 1605



Anthrazitgrau Glatt
Art.-Nr. 017 K 1605-083



Schwarzbraun
Art.-Nr. 017 K 1805



Eiche Dunkel
Art.-Nr. 017 K 2089

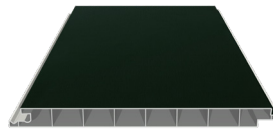

Dunkelgrün
Art.-Nr. 017 K 2505



Quarzgrau
Art.-Nr. 017 K 3905



Lichtgrau
Art.-Nr. 017 K 5105



Silbergrau
Art.-Nr. 017 K 5505

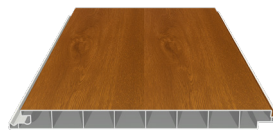

Golden Oak
Art.-Nr. 017 K 8001



Nussbaum
Art.-Nr. 017 K 8007

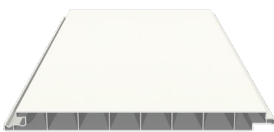

Weiß
Art.-Nr. 017 K PX 5205



Cremeweiß
Art.-Nr. 017 K PX 7905



Black Ulti Matt
Art.-Nr. 017 K PX 47097

**weitere Dekore
auf Anfrage**

Verkleidungsprofile ohne Fuge - mit Dekor-Folie

- Zubehörprofile -

U-Profil

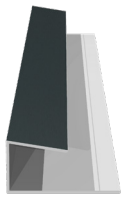

Maße + Länge	VE	Art.-Nr.
24 x 21 x 6000 mm	60 m	021 K

H-Profil

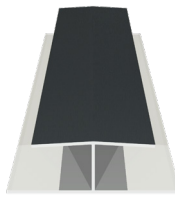

Maße + Länge	VE	Art.-Nr.
47 x 6000 mm	60 m	023 K

Eck-Profil



Maße + Länge	VE	Art.-Nr.
37 x 37 x 6000 mm	60 m	022 K

Befestigungsklammer



VE	Art.-Nr.
100 Stück	026

- ✓ außen und innen verwendbar
- ✓ witterungsbeständig
- ✓ wartungsfrei / nie wieder streichen
- ✓ 100 % recyclebar
- ✓ Verarbeitung wie Holz
- ✓ 10 Jahre Garantie auf UV- und Witterungsbeständigkeit
- ✓ sehr reinigungsfreundlich
- ✓ Made in Germany
- ✓ leichte Montage - vertikal und horizontal einsetzbar
- ✓ moderne attraktive Farben

Hartschaumwinkel



Maße + Länge	VE	Art.-Nr.
310 x 40 x 6000 mm	12 m	S31040 K

Hartschaumwinkel

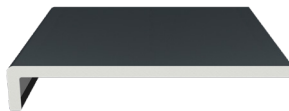

Maße + Länge	VE	Art.-Nr.
235 x 40 x 6000 mm	12 m	S23540 K

Hartschaumwinkel



Maße + Länge	VE	Art.-Nr.
185 x 40 x 6000 mm	12 m	S18540 K



Dekor: Altweiß

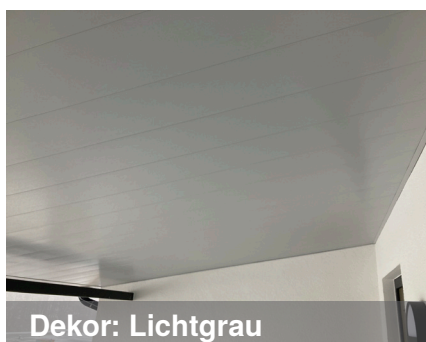

Dekor: Lichtgrau



Dekor: Anthrazitgrau

Hartschaumwinkel Weiß

Hartschaumwinkel

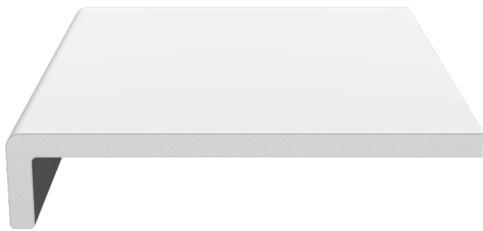

Maße + Länge	VE	Art.-Nr.
110 x 40 x 6000 mm	12 m	S11040
160 x 40 x 6000 mm	12 m	S16040
185 x 40 x 6000 mm	12 m	S18540
210 x 40 x 6000 mm	12 m	S21040
235 x 40 x 6000 mm	12 m	S23540
260 x 40 x 6000 mm	12 m	S26040
310 x 40 x 6000 mm	12 m	S31040
423 x 40 x 6000 mm	12 m	S4042340

- Zubehörprofile -

Außenecke



VE	Art.-Nr.
100 Stück	SWE 310

Verbinder



VE	Art.-Nr.
100 Stück	SWV 310

Innenecke



VE	Art.-Nr.
100 Stück	SWI 310



Dekor: Anthrazitgrau



Weiß

Hartschaumwinkel mit Dekor-Folie

Hartschaumwinkel



Maße + Länge	VE	Art.-Nr.
185 x 40 x 6000 mm	12 m	S18540 K
235 x 40 x 6000 mm	12 m	S23540 K
310 x 40 x 6000 mm	12 m	S31040 K

Außenecke

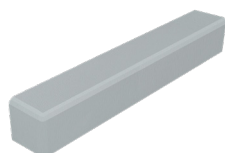

VE	Art.-Nr.
10 Stück	SWE 310 F

Verbinder



VE	Art.-Nr.
10 Stück	SWV 310 F

Innenecke

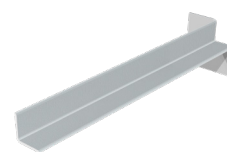

VE	Art.-Nr.
10 Stück	SWI 310 F

Lager - Sortiment



Moosgrün
Art.-Nr. S18540 K 0505



Basaltgrau
Art.-Nr. S18540 K 1205



Anthrazitgrau
Art.-Nr. S18540 K 1605



Anthrazitgrau Glatt
Art.-Nr. S18540 K 1605-083



Schwarzbraun
Art.-Nr. S18540 K 1805



Eiche Dunkel
Art.-Nr. S18540 K 2089



Dunkelgrün
Art.-Nr. S18540 K 2505



Quarzgrau
Art.-Nr. S18540 K 3905



Lichtgrau
Art.-Nr. S18540 K 5105



Silbergrau
Art.-Nr. S18540 K 5505



Golden Oak
Art.-Nr. S18540 K 8001



Nussbaum
Art.-Nr. S18540 K 8007



Weiß
Art.-Nr. S18540 K PX 5205



Cremeweiß
Art.-Nr. S18540 K PX 7905



Black Ulti Matt
Art.-Nr. S18540 K PX 47097

**weitere Dekore
auf Anfrage**

Fassadenprofile

Fassadenprofil mit Schattenfuge



Maße + Länge	Deckbreite	VE	Art.-Nr.
17 x 6000 mm	180 mm	30 m / 5,4 m ²	016 K

Lager - Sortiment



Anthrazitgrau
Art.-Nr. 016 K 1605

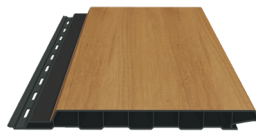

Desert Oak
Art.-Nr. 016 K 2.0057.004

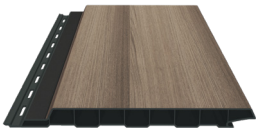

Anteak
Art.-Nr. 016 K 324 1002-195

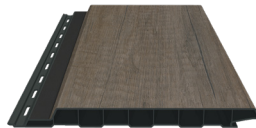

Monument Oak
Art.-Nr. 016 K 2.0057.006

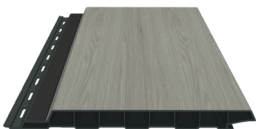

Grey Amanita Oak Super Matt
Art.-Nr. 016 K 8002-02201

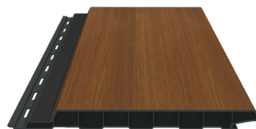

Honey Oak Super Matt
Art.-Nr. 016 K 8007-02201



Coriander Oak Super Matt
Art.-Nr. 016 K 8011-02201

**weitere Dekore
auf Anfrage**



Druckfehler vorbehalten

Fassadenprofile

- Zubehörprofile -

**Alu/PVC Eck-Profil
(zweiteilig)**

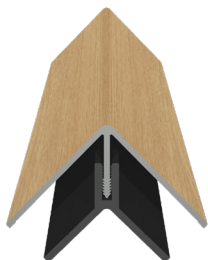

Maße + Länge	VE	Art.-Nr.
50 x 50 x 6000 mm	12 m	1725 K

**Alu/PVC H-Profil
(zweiteilig)**



Maße + Länge	VE	Art.-Nr.
50 x 6000 mm	12 m	1723 K

**Alu/PVC U-Profil
(zweiteilig)**



Maße + Länge	VE	Art.-Nr.
50 x 21 x 6000 mm	12 m	1724 K

**Variables Eck-Profil
(dreiteilig)**



Bestehend aus
zweiteiligem Alu/PVC U-Profil
und 3 mm Flachprofil

Alu Startprofil

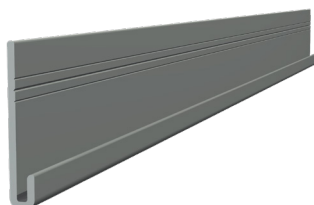

Maße + Länge	VE	Art.-Nr.
30 x 3000 mm	3 m	1726

**Befestigungsschraube
für Art.-Nr. 016**



Empfohlene Schraube:
Panhead Edelstahlschraube 3,5 x 30 mm
(bauseits, nicht im Lieferprogramm enthalten!)



Dekor: Coriander Oak

Fassadenprofil mit Schattenfuge

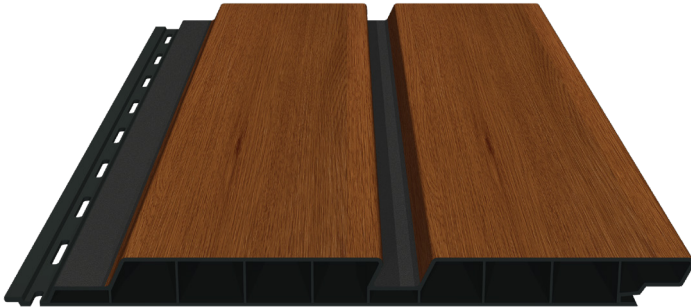

Maße + Länge	Deckbreite	VE	Art.-Nr.
17 x 6000 mm	200 mm	30 m / 6 m ²	018 K

Lager - Sortiment



Anthrazitgrau
Art.-Nr. 018 K 1605

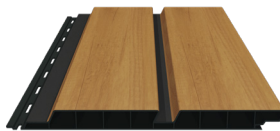

Desert Oak
Art.-Nr. 018 K 2.0057.004

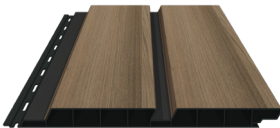

Anteak
Art.-Nr. 018 K 324 1002-195

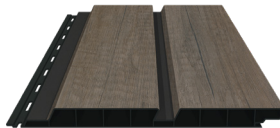

Monument Oak
Art.-Nr. 018 K 2.0057.006

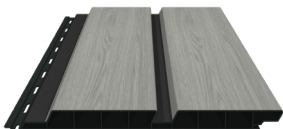

Grey Amanita Oak Super Matt
Art.-Nr. 018 K 8002-02201

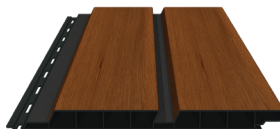

Honey Oak Super Matt
Art.-Nr. 018 K 8007-02201



Coriander Oak Super Matt
Art.-Nr. 018 K 8011-02201

**weitere Dekore
auf Anfrage**



Fassadenprofile

- Zubehörprofile -

**Alu/PVC Eck-Profil
(zweiteilig)**

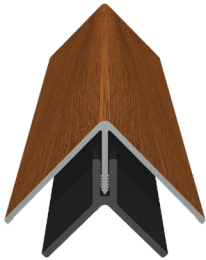

Maße + Länge	VE	Art.-Nr.
50 x 50 x 6000 mm	12 m	1725 K

**Alu/PVC H-Profil
(zweiteilig)**



Maße + Länge	VE	Art.-Nr.
50 x 6000 mm	12 m	1723 K

**Alu/PVC U-Profil
(zweiteilig)**



Maße + Länge	VE	Art.-Nr.
50 x 21 x 6000 mm	12 m	1724 K

**Variables Eck-Profil
(dreiteilig)**



Bestehend aus
zweiteiligem Alu/PVC U-Profil
und 3 mm Flachprofil

Alu Startprofil

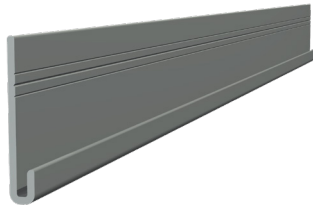

Maße + Länge	VE	Art.-Nr.
30 x 3000 mm	3 m	1726

**Befestigungsschraube
für Art.-Nr. 018**

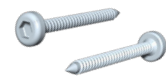

Empfohlene Schraube:
Panhead Edelstahlschraube 3,5 x 30 mm
(bauseits, nicht im Lieferprogramm enthalten!)



Dekor: Desert Oak

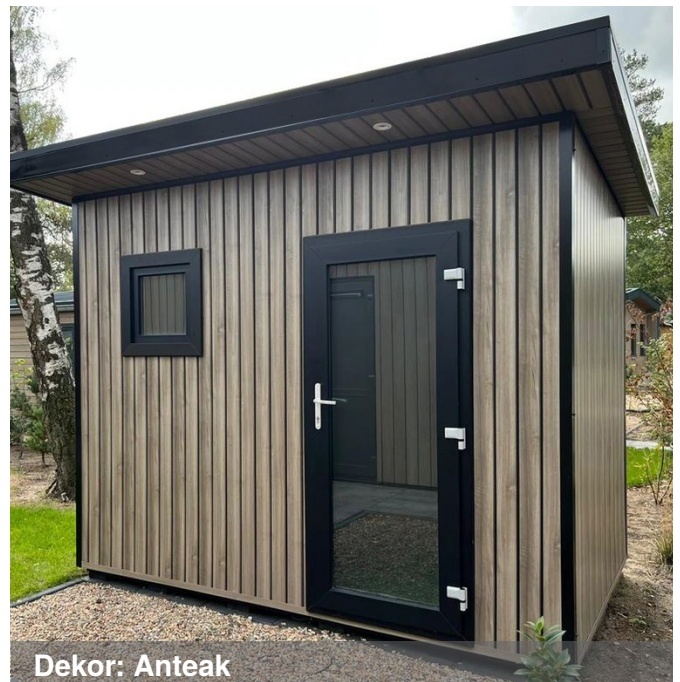

Dekor: Anteak

Fassadenprofil



Maße + Länge	Deckbreite	VE	Art.-Nr.
17 x 6000 mm	180 mm	30 m / 5,4 m ²	019 K

Lager - Sortiment



Anthrazitgrau
Art.-Nr. 019 K 1605

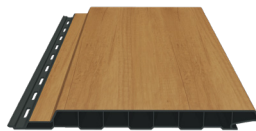

Desert Oak
Art.-Nr. 019 K 2.0057.004



Anteak
Art.-Nr. 019 K 324 1002-195

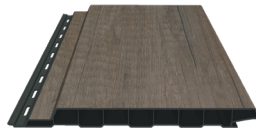

Monument Oak
Art.-Nr. 019 K 2.0057.006



Grey Amanita Oak Super Matt
Art.-Nr. 019 K 8002-02201

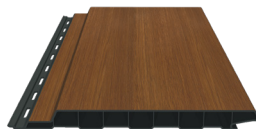

Honey Oak Super Matt
Art.-Nr. 019 K 8007-02201



Coriander Oak Super Matt
Art.-Nr. 019 K 8011-02201

**weitere Dekore
auf Anfrage**



Fassadenprofile

- Zubehörprofile -

**Alu/PVC Eck-Profil
(zweiteilig)**

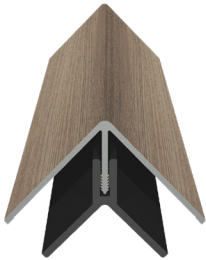

Maße + Länge	VE	Art.-Nr.
50 x 50 x 6000 mm	12 m	1725 K

**Alu/PVC H-Profil
(zweiteilig)**



Maße + Länge	VE	Art.-Nr.
50 x 6000 mm	12 m	1723 K

**Alu/PVC U-Profil
(zweiteilig)**



Maße + Länge	VE	Art.-Nr.
50 x 21 x 6000 mm	12 m	1724 K

**Variables Eck-Profil
(dreiteilig)**



Bestehend aus
zweiteiligem Alu/PVC U-Profil
und 3 mm Flachprofil

Alu Startprofil

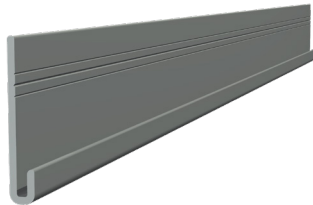

Maße + Länge	VE	Art.-Nr.
30 x 3000 mm	3 m	1726

**Befestigungsschraube
für Art.-Nr. 019**

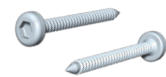

Empfohlene Schraube:
Panhead Edelstahlschraube 3,5 x 30 mm
(bauseits, nicht im Lieferprogramm enthalten!)



Dekor: Anteak

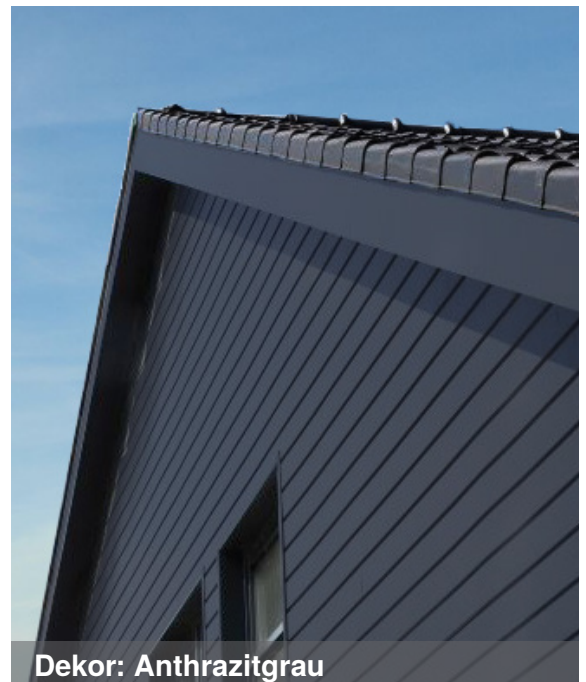

Dekor: Anthrazitgrau



Menke Kunststoffe GmbH & Co. KG

Mescheder Schling 1

59581 Warstein

Germany

Tel.: +49 (0) 2902 97080

E-Mail: info@mk-profile.de

www.mk-profile.de



Dach & Fassaden - Verkleidungen

www.wetterpan.de

Montageanleitungen:

